

# SCHLAGE®

## D-Lock

A NEW STANDARD IN GRADE 1 SECURITY



**IR** Security & Safety

**SCHLAGE®**  
Access Control and Key Systems Management

## Extra Heavy Duty Commercial

*D-Series locks are for commercial, institutional and industrial use, such as schools, hospitals and factories, where a long life of dependable operation must be combined with a high degree of resistance to physical abuse.*

*Popular functions of all lever designs are also available in Vandlgard®, where levers are free-wheeling in the locked position to resist more forceful attacks.*

## Performance Features

Tested to exceed 3,000,000 cycles, greatly exceeding the 800,000 cycle ANSI Grade 1 requirement.

Exceeds ANSI A156.2 Series 4000 Grade 1 locked lever torque requirements.

Vandlgard® functions have free-wheeling levers to resist force when locked.

Independent heavy duty spring cages for effective lever support.

Thru-bolted mechanism for positive interlock to door.

Concealed mounting screws.

Steel Latchbolt.

INDEX	
Cylinders	8
Designs & Finishes	4
Door Preparation	3
Door Handing	12
Exploded View	2
Functions	6 - 7
How to Order	13
Interchangeable Cores	8 - 9
Latches	10
Performance Features	2
Specifications	3
Strikes	11
Vandlgard® Features	5
Wiring for Electrified Locks	12

## Exploded View

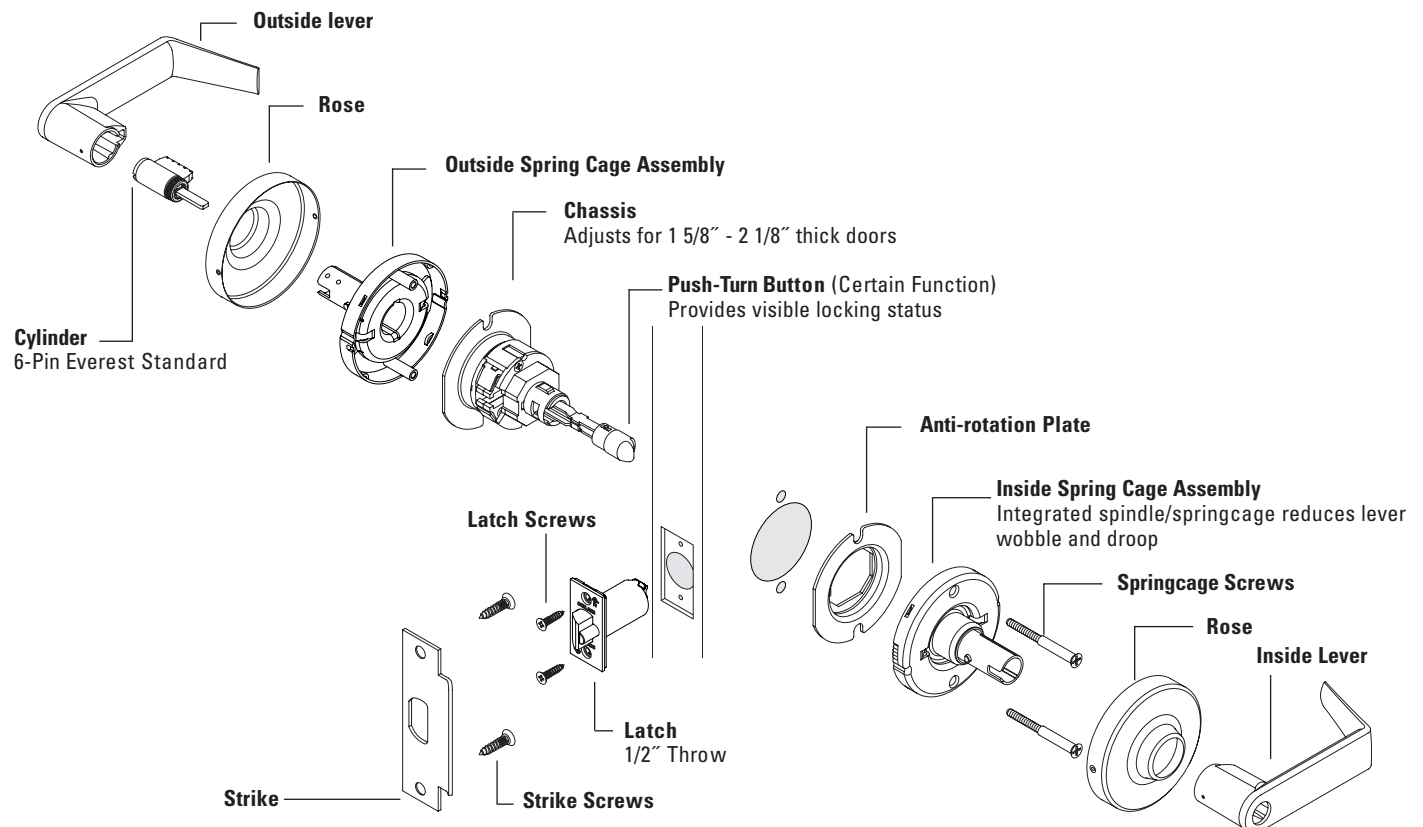

## Specifications

### Handing:

All D-Series lever locksets are non-handed.

### Door Thickness:

1 $\frac{3}{8}$ " to 2 $\frac{1}{8}$ " (41mm–54mm) standard including Vandlgard® functions. 1 $\frac{3}{4}$ " - 2" for function D85. See accessories (Page 11) for spacers required for 1 $\frac{3}{8}$ " doors.

### Backset:

2 $\frac{3}{4}$ " (70mm) standard. 2 $\frac{3}{8}$ ", 3 $\frac{3}{4}$ " and 5" (60mm, 95mm, 127mm) optional.

### Faceplate:

Brass, bronze or stainless steel. 1 $\frac{1}{8}$ " x 2 $\frac{1}{4}$ " (29mm x 57mm) square corner, beveled.

### Lock Chassis:

Zinc plated for corrosion resistance.

### Latch Bolt:

Steel,  $\frac{1}{2}$ " (12mm) throw, deadlocking on keyed and exterior functions.  $\frac{3}{4}$ " (19mm) throw anti-friction latch available for pairs of fire doors.

### Exposed Trim:

Levers: Pressure cast zinc, plated to match finish symbols.  
Roses: Solid brass.

### Strike:

ANSI curved lip strike 1 $\frac{1}{4}$ " x 4 $\frac{7}{8}$ " x 1 $\frac{3}{16}$ " lip to center standard. Optional strikes, lip lengths and ANSI strike box available. See page 12.

### Cylinder & Keys:

6-pin Everest C123 keyway standard with two patented nickel silver keys per lock.

### Keying Options:

Interchangeable core and Primus® high security cylinders. Master keying, grand master keying and construction keying.

### Warranty:

Seven-year limited for all functions including Vandlgard®.

## Door Preparation

### Lever Designs

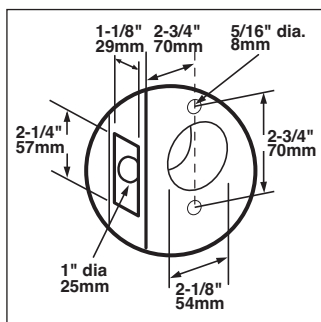

## Certifications

### ANSI

Meets or exceeds A156.2 Series 4000, Grade 1 strength and operational requirements. Meets A117.1 Accessibility Code.

### Federal

Meets FF-H-106C Series 161.

### California State Reference Code (CSFH)

(Formerly Title 19, California State Fire Marshal Standard)

All levers with less than  $\frac{1}{2}$ " (64mm) returns comply; levers return to within  $\frac{1}{2}$ " of door face.

### MEA Certification

All electrified locking (fail-safe, unlocked by switch or power failures) functions accepted for use in New York City by the City of New York, Department of Buildings (MEA 24-04-E).

All levers with less than  $\frac{1}{2}$ " (64mm) returns comply with California Fire Safety Codes.

3/4" and 1/2" throw latch approved for Hurricane Resistance with Miami-Dade County, Florida and the Florida Building Commission.

### UL / cUL:

All locks listed for A label single doors, 4' x 8'. Letter F and UL symbol



# D SERIES LEVERS

## Lever Designs & Finishes



606

### ATHENS

Symbol: ATH (L-Series 07)  
Material: Pressure cast zinc lever; wrought brass rose  
Finishes:  
605, 606, 612,  
613, 619, 625,  
626

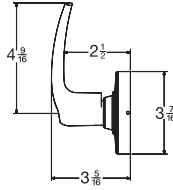

626

### SPARTA

Symbol: SPA (L-Series 17)  
Material: Pressure cast zinc lever; wrought brass rose  
Finishes:  
605, 606, 612,  
613, 619, 625,  
626

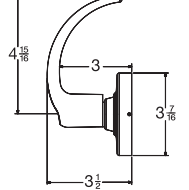

612

### RHODES

Symbol: RHO (L-Series 06)  
Material: Pressure cast zinc lever; wrought brass rose  
Finishes:  
605, 606, 612,  
613, 619, 625,  
626

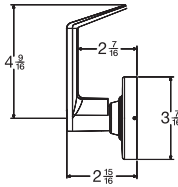

619

### OMEGA

Symbol: OME (L-Series Omega)  
Material: Pressure cast zinc lever; wrought brass rose  
Finishes:  
605, 606, 612,  
613, 619, 625,  
626

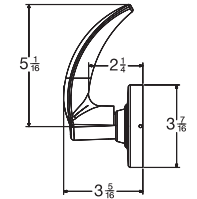

626

### TUBULAR (L-Series 03)

Symbol: TLR  
Material: Pressure cast zinc lever; wrought brass rose  
Finishes:  
605, 606, 612,  
613, 619, 625,  
626

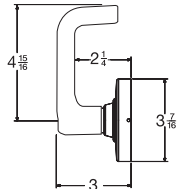

605  
Bright Brass



606  
Satin Brass



612  
Satin Bronze



613  
Oil Rubbed  
Bronze



619  
Satin Nickel



625  
Bright Chromium  
Plated



626  
Satin Chromium  
Plated

### Finishes

- 605 Bright Brass
- 606 Satin Brass
- 612 Satin Bronze
- 613 Oil Rubbed Bronze
- 619 Satin Nickel
- 625 Bright Chromium Plated
- 626 Satin Chromium Plated

Keyed functions available with Full Size Interchangeable Core options.

Keyed functions available with Small Format Interchangeable Core options.

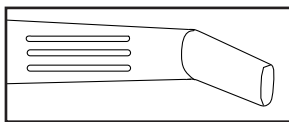

### TACTILE WARNING (KNURLING)

Change symbol designation as follows:

**8AT** for Athens

**8RO** for Rhodes

**8SP** for Sparta

**8TR** for Tubular\*

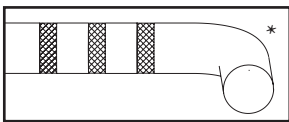

\*Only available with Tubular lever.

Only outside lever is knurled unless otherwise specified.

Not available with Omega trim

Extended Factory Lead Time

# D-SERIES WITH VANDLGARD™

Schlage D-Series keyed lever locks with Vandlgard provide vandal resistant technology. Designed for maximum accessibility, security and durability, Vandlgard sets the standard for door hardware in educational facilities and other applications subject to heavy traffic or abuse. The unique features of Vandlgard prevent damage to internal lock components caused by excessive force from persons kicking, hitting or standing on the lever to gain access. Vandlgard functions maintain total key system and architectural design compatibility with Schlage's regular D-Series cylindrical locks.

Levers have virtually replaced knobs in the marketplace for handicap accessibility. The added grip and leverage has created an increased opportunity for abuse or vandalism. This abuse often renders locks inoperable. In some cases the security of the door is violated leaving computer and laboratory equipment susceptible to theft. While this type of abuse is commonly associated with junior and senior high schools, it also occurs in universities, office buildings, commercial buildings, and public buildings.



Locked lever freely rotates up and down while remaining securely locked. The Vandlgard function also increases resistance to over-rotation of the lever.

## *Benefits & Features*

### *Superb warranty.*

*All Vandlgard functions have a 7-year warranty.*

### *Reduce lever wobble and play.*

*Integrated spindle and spring cage greatly reduces lever sag and wobble.*

### *Resists vandalism.*

*Free-wheeling lever eliminates the ability to stand or exert excessive force on the end of the lever.*

### *Ease of installation.*

*Installs in under 2 minutes.*

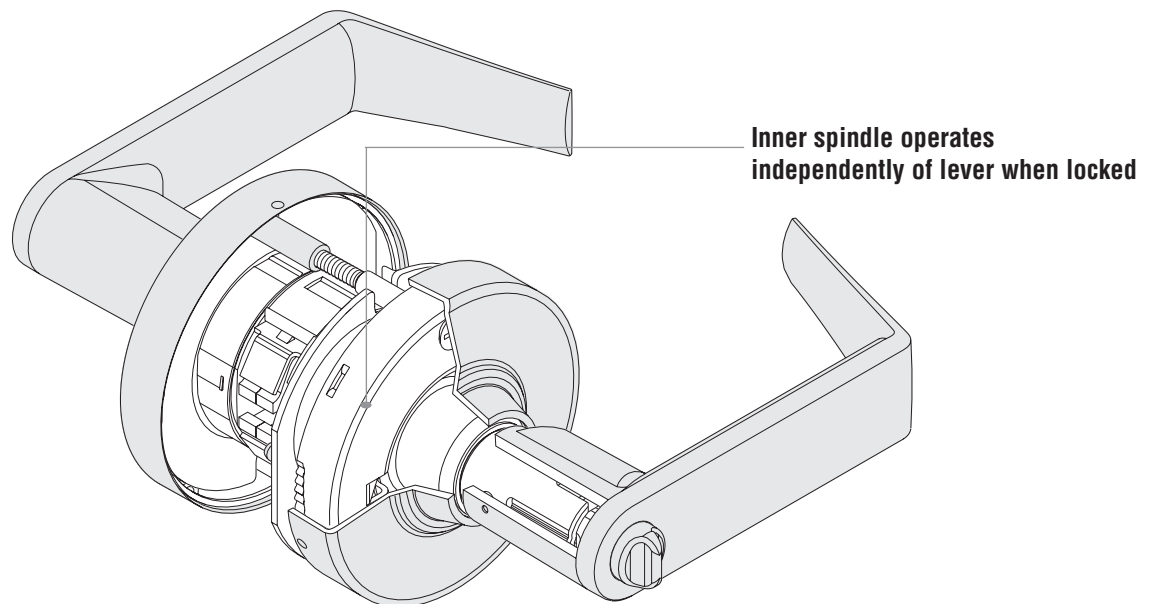

*D-Series Vandlgard levers comply with ADA requirements. ♿*

## Functions

### ANSI A156.2 Series 4000 Grade 1

#### Non-Keyed Locks

SCHLAGE ANSI

**ND10S F75**

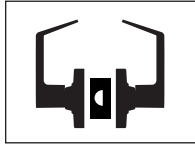

#### Passage Latch

Both levers always unlocked.

**ND12D F89**

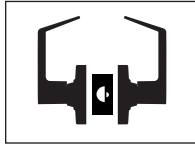

#### Exit Lock

Outside lever always fixed. Inside lever always unlocked.

**ND12DEL**

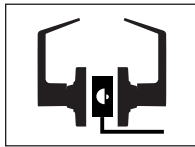

#### Electrically Locked (Fail Safe)

Outside lever continuously locked electrically. Unlocked by switch or power failure. Auxiliary latch deadlocks latchbolt when door is closed. Inside lever always free for immediate exit.

**ND12DEU**

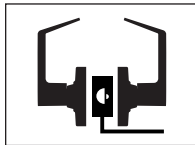

#### Electrically Unlocked (Fail Secure)

Outside lever continuously locked until unlocked by electric current. Auxiliary latch deadlocks latchbolt when door is closed. Inside lever always free for immediate exit.

**ND25D**



#### Exit Lock

Blank plate outside. Inside lever always unlocked.

**ND40S F76**

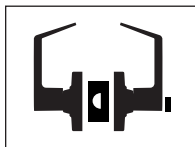

#### Bath/Bedroom Privacy Lock

Push-button locking. Can be opened from outside with small screwdriver. Turning inside lever or closing door releases button.

**ND44S**

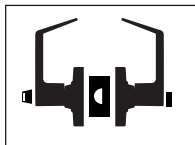

#### Hospital Privacy Lock

Push-button locking. Unlocked from outside by turning emergency turn-button. Turning inside lever or closing door releases button.

**ND170**



#### Single Dummy Trim

Dummy trim for one side of door. Used for door pull or as matching inactive trim.

#### Keyed Locks

SCHLAGE ANSI

**ND50PD F82**

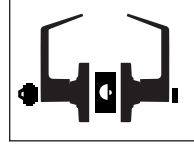

#### Entrance/Office Lock †

Push-button locking. Push-button locks outside lever until unlocked with key or by turning inside lever.

**ND53PD F109**

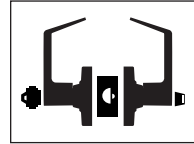

#### Entrance Lock †

Turn/push-button locking; pushing and turning button locks outside lever, requiring use of key until button is manually unlocked. Push-button locking; pushing button locks outside lever until unlocked by key or by turning inside lever.

**ND60PD F88**

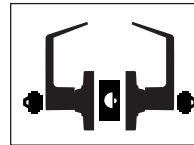

#### Vestibule Lock †

Latch retracted by key from outside when outside lever is locked by key in inside lever. Inside lever is always unlocked.

**ND66PD F91**

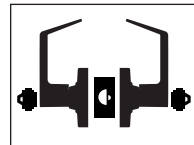

#### Store Lock † \*

Key in either lever locks or unlocks both levers.

**ND70PD F84**

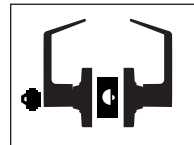

#### Classroom Lock †

Outside lever locked and unlocked by key. Inside lever always unlocked.

**ND73PD F90**

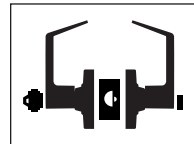

#### Corridor Lock †

Locked or unlocked by key from outside. Push-button locking from inside. Turning inside lever or closing door releases button. When outside lever is locked by key it can only be unlocked by key. Inside lever is always unlocked.

**ND75PD**

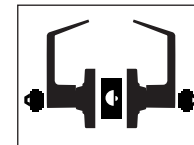

#### Classroom Security Lock †

Key in either lever locks or unlocks outside lever. Inside lever is always unlocked.

† Keyed functions available with 6-pin (PD/LD), SFIC(GD/BD), or FSIC(RD/JD) cylinder.

\* **Caution:** Double cylinder locks on residences and any door in any structure which is used for egress are a life safety hazard in times of emergency and their use is not recommended. Installation should be in accordance with existing codes only.

*Functions*

**ANSI A156.2 Series 4000 Grade 1**

**Keyed Locks**

SCHLAGE ANSI

**ND80PD F86**

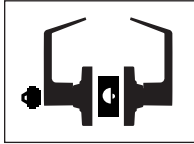

**Storeroom Lock †**  
Outside lever fixed. Entrance by key only. Inside lever always unlocked.

**ND80PDEL**

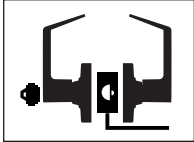

**Electrically Locked (Fail Safe) †**  
Outside lever continuously locked electrically. Unlocked by key outside or by switch or power failure. Auxiliary latch deadlocks latchbolt when door is closed. Inside lever always free for immediate exit.

**ND80PDEU**

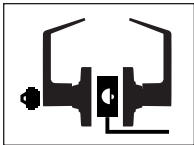

**Electrically Unlocked (Fail Secure) †**  
Outside lever continuously locked until unlocked by key or electric current. Auxiliary latch deadlocks latchbolt when door is closed. Inside lever always free for immediate exit.

**ND82PD F87**

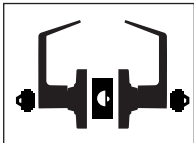

**Institution Lock † \***  
Both levers fixed. Entrance by key in either lever.

**ND85PD**

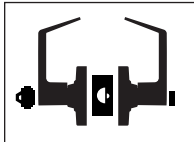

**Faculty Restroom Lock \*\***   
Outside lever fixed. Entrance by key only. Push-button in inside lever activates visual “occupancy” indicator, allowing only emergency master key to operate. Turning inside lever or closing door releases visual occupancy indicator. Rotation of inside spinner-button provides lock-out feature by keeping indicator thrown.

 *Safe School Locks*

† Keyed functions available with 6-pin (PD/ILD), SFIC(GD/BD), or FSIC(RD/JD) cylinders.

\* *Caution: Double cylinder locks on residences and any door in any structure which is used for egress are a life safety hazard in times of emergency and their use is not recommended. Installation should be in accordance with existing codes only.*

\*\* 85 function locks are not available in Full Size & Small Format Interchangeable Cores.

**Vandlgard Functions**

SCHLAGE ANSI

**ND91PD F82**

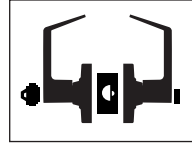

**Entrance/Office Lock †**  
Push-button locking. Push-button disengages outside lever until unlocked with key or by turning inside lever. Vandlgard is designed to disengage outside spindle from latch when in locked condition.

**ND92PD F109**

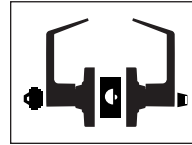

**Entrance Lock †**  
Turn/push-button locking; pushing and turning button disengages outside lever, requiring use of key until button is manually unlocked. Push-button locking; pushing button disengages outside lever until unlocked by key or by turning inside lever. Vandlgard is designed to disengage outside spindle from latch when in locked condition.

**ND93PD F88**

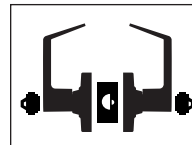

**Vestibule Lock †**  
Latch retracted by key from outside when outside lever is disengaged by key in inside lever. Inside lever is always unlocked. Vandlgard is designed to disengage outside spindle from latch when in locked condition.

**ND94PD F84**

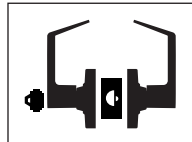

**Classroom Lock †**   
Outside lever disengaged and unlocked by key. Inside lever always unlocked. Vandlgard is designed to disengage outside spindle from latch when in locked condition.

**ND95PD**

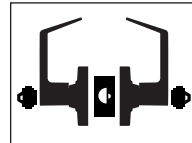

**Classroom Security Lock †**   
Key in either lever locks or unlocks outside lever. Inside lever is always unlocked.

**ND96PD F86**

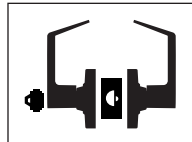

**Storeroom Lock †**  
Outside lever always disengaged. Entrance by key only. Inside lever always unlocked. Vandlgard is designed to disengage outside spindle from latch when in locked condition.

**ND96PDEL**

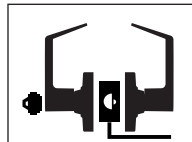

**Electrically Locked (Fail Safe) †**  
Outside lever continuously disengaged electrically. Unlocked by key outside or by switch or power failure. Auxiliary latch deadlocks latchbolt when door is closed. Inside lever always free for immediate exit. Vandlgard is designed to disengage outside spindle from latch when in locked condition.

**ND96PDEU**

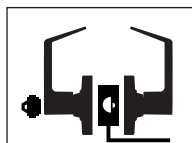

**Electrically Unlocked (Fail Secure) †**  
Outside lever continuously disengaged until unlocked by key or electric current. Auxiliary latch deadlocks latchbolt when door is closed. Inside lever always free for immediate exit. Vandlgard is designed to disengage outside spindle from latch when in locked condition.

*Standard Cylinders*

Schlage® locks are provided with cylinders precision built to extremely close tolerances and the highest standards of accuracy. Using only solid brass plugs, extruded brass shells, phosphor bronze springs, nickel silver keys and pins, ensures long life and ease of operation. For complete listing of cylinder parts, refer to the New D-Series Service Manual (SC-2058).

Conventional cylinders are available in Classic keyways or in patented Everest® keyways. Specify keyway to differentiate between Everest and Classic. Example: C (Classic) vs. C123 (Everest).

*Primus® High Security Cylinders*

Primus high security cylinders are available to add patented key control and varying degrees of geographical exclusivity to most Schlage 6-pin key systems, whether Everest or Classic keyways.

In addition to a conventional pin tumbler mechanism, Primus cylinders incorporate a patented finger pin and sidebar design providing a “dual-locking” cylinder that is virtually pick-proof. Resistance to drilling and other physical attack is optional by specifying 20-500 Series UL437 Listed cylinders.

Classic Primus cylinders are recommended for upgrading existing Classic key systems. Due to its extended patent life, the newly designed Everest Primus is recommended for new key systems and for upgrading existing Everest® key systems. Specify keyway to differentiate between Everest and Classic. Example: CP (Classic) vs. C123 (Everest).

**Cylinder for Most Functions**

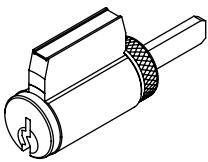

Tailpiece is vertical (shown) for levers.

**Standard Cylinders\***

Levers	Description
23-065	6-Pin conventional (standard)
20-765	Primus high security
20-565	Primus UL437 Listed high security
23-000	Hotel cylinder
N123-042	Temporary construction plug, plastic for functions

\*Available in 606 and 626 finish only. Everest C123 keyway standard.

*Full Size Interchangeable Core* 

Schlage® figure-8 interchangeable core (IC) locksets allow immediate rekeying at the door simply by using a special control key to replace the core.



Available in all lever designs, full size interchangeable cores can be integrated into any 5 or 6-pin Schlage key.

To order complete locks with full size cores, change suffix from PD to RD. Example: ND53RD. To order locks less core, change suffix to JD. To order with full size construction core, change suffix to TD.

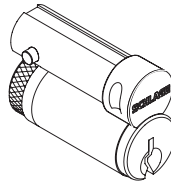

**Full Size Interchangeable Cores\***

Number	Description
23-030	Conventional core
20-740	Primus high security core

\*Available 606 and 626 finish only. Everest C123 keyway standard.

**Driver**  
N123-127

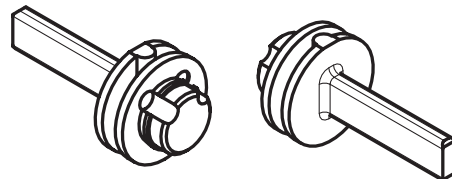

## Small Format Interchangeable Core



Available in all lever designs, the small format IC option is designed for Schlage Everest® B Family Restricted keyway cores and is also completely compatible with Best®, Falcon®, and other small format interchangeable cores.

To order complete locks with Everest B Family *Restricted keyway cores*, change product suffix from PD to GD and provide letter of authorization from end user. Example: ND53GD. To order locks less core, change suffix to BD. To order with keyed brass construction cores, change suffix to HD. To order with disposable plastic construction cores, change suffix to BDC.

### Small Format Core

### Disposable Construction Core

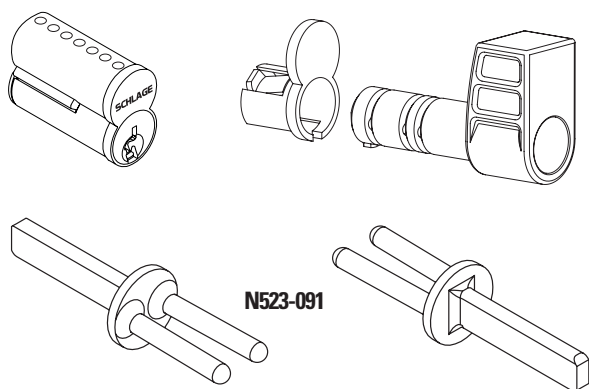

### Small Format Interchangeable Cores

Number	Description
80-036	7-Pin uncombined Everest B Family Restricted keyways
80-037	7-Pin combined Everest B Family Restricted keyways
80-043	6-pin uncombined Falcon / Best keyways
80-033	7-pin uncombined Falcon / Best keyways
M204-152*	Disposable plastic construction core
N523-091	SFIC Driver

Available 606 and 626 finish only. Specify keyway for existing systems.

80-033 and 80-043 cores are available in Best A, D, E, F, G, H, J, K, L, and M keyways. Specify keyway by suffixing "B" to keyway letter, e.g. "AB".

80-036 and 80-037 Restricted keyway cores require a letter of authorization from the end user. Schlage assigns the keyway when establishing new Everest Restricted key systems.

\*M204-152 does not have a finish option.

## Latches

D-Series latches are adjustable for flat or beveled edge doors. Latches and strikes are furnished in brass, bronze, or chrome finishes to be compatible with lock trim. When ordering, specify quantity, part number, and finish. All D-Series latches have 1/2" throw and 1" housings except 2 3/8" backset latches, which includes sleeve G506-815 to fill a 1" edge bore. Standard latches are shown in bold type.

### Latches

Backset	Description	Deadlatch 1/2" Throw	Springlatch 1/2" Throw
<b>2 3/8"</b> 60mm	1 1/8" (29mm) x 2 1/4" (57mm) square corner	14-047	—
	1" (25mm) x 2 1/4" (57mm) square corner	14-048	—
<b>2 3/4"</b> 70mm	1 1/8" (29mm) x 2 1/4" (57mm) square corner	<b>13-047</b>	<b>13-048</b>
	1 1/8" (29mm) x 2 1/4" (57mm), 3/4" (19mm) throw for pairs of fire doors	14-042	—
<b>3 3/4"</b> 95mm	1 1/8" (29mm) x 2 1/4" (57mm) Square corner	14-028	14-010

### Deadlatch

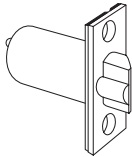

### Springlatch

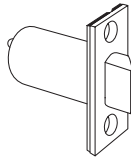

### 3/4" Throw Anti-Friction Deadlatch for Pairs of Fire Doors

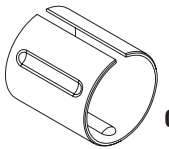
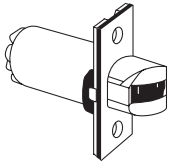

G506-815

## Strikes

All Schlage strikes are furnished complete with screws. The standard D-Series strike has a 1 3/16" lip. When ordering separately specify quantity, product number, finish, and lip length. Standard strikes are shown in bold type.

### Strikes

Number	Lip Length	Description
10-013	1 1/8" (28mm)	1 1/8" x 2 3/4" (28mm x 70mm) Square corner, box 1 3/4" (38mm)
10-016	1 1/8" (28mm)	1 1/8" x 2 3/4" (28mm x 70mm), 3/4" (19mm) deep box for 14-042 fire door latch
<b>10-025</b>	<b>1 3/16" (30mm)</b> <b>1 3/8" (35mm)</b>	<b>1 1/4" x 4 7/8" (32mm x 124mm) ANSI</b>
K510-066	—	Box for 10-025 ANSI strike

## Long Backsets

D-Series locks with 5" backsets are normally furnished with 1 1/8" faceplates and 1" housings. Links installed in metal doors require one A501-567 sleeve and 43-005 (order separately) to join latch and link.

### 2-3/4" Latch

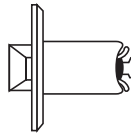

### Extension Link (43-005)



### Sleeve (A501-567)



(add to 2 3/4" backset latch)

## Door Reinforcement

Schlage 37-001 reinforcing kit is used to reinforce and help prevent the collapse of hollow metal doors when locksets are tightly mounted.

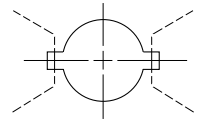

This kit should be used with long backsets for D-Series lock installations in hollow metal doors to prevent lateral movement of the latchbolt. Specify door thickness, 1 3/8" or 1 3/4", when ordering reinforcement kits.

### Reinforcement Kit (37-001)

(37-001)

### Sleeve (A501-567)

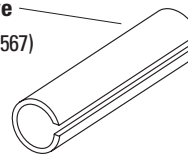

### Reinforcement

1 3/4" doors (A501-566) or  
1 3/8" doors (A501-565)

### ANSI Strike—Standard (10-025)

1 1/4" x 4 7/8" x 3/32"



### Square Corner Box Strike (10-013)

1 1/8" x 2 3/4" x 3/32"

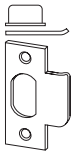

## Rabbeted Latch and Strike Kit

Rabbeted latch and strike kit finishes: 605, 626.

This kit adapts square corner latches and 2 3/4" (28mm) high strikes for 1/2" (13mm) rabbeted door and frame preparations.

### Rabbeted Latch and Strike Kit (39-030)

(39-030)

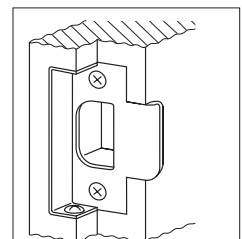
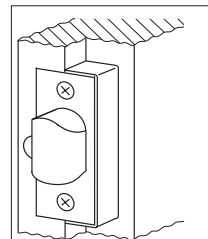

## Typical Wiring Diagram for Electrified Locks

### AC Power Source – EL or EU

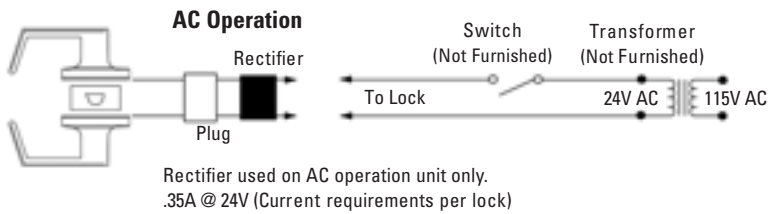

### DC Power Source – EL or EU

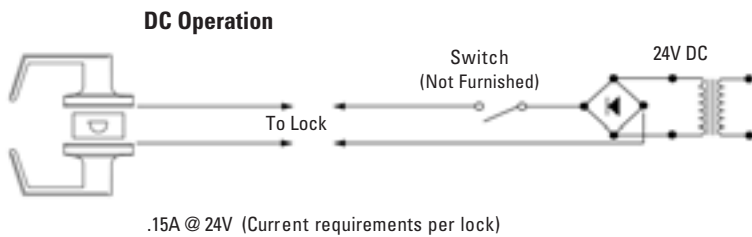

### AC and DC Application

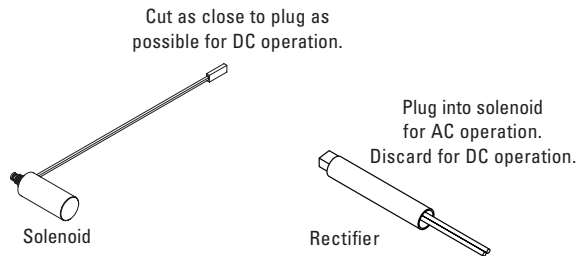

## Accessories

### 1-3/8" D-Series Lever Door Spacer\*



\*For installation on 1 3/8" doors, two (2) spacers are required. Specify finish.

## Door Handing

All Schlage® locks are reversible. Hand information is necessary to ensure proper finish of latchbolt and strike for split-finish locks. Follow the diagram to determine the hand of the door. The outside is the secure side or the corridor side.

